

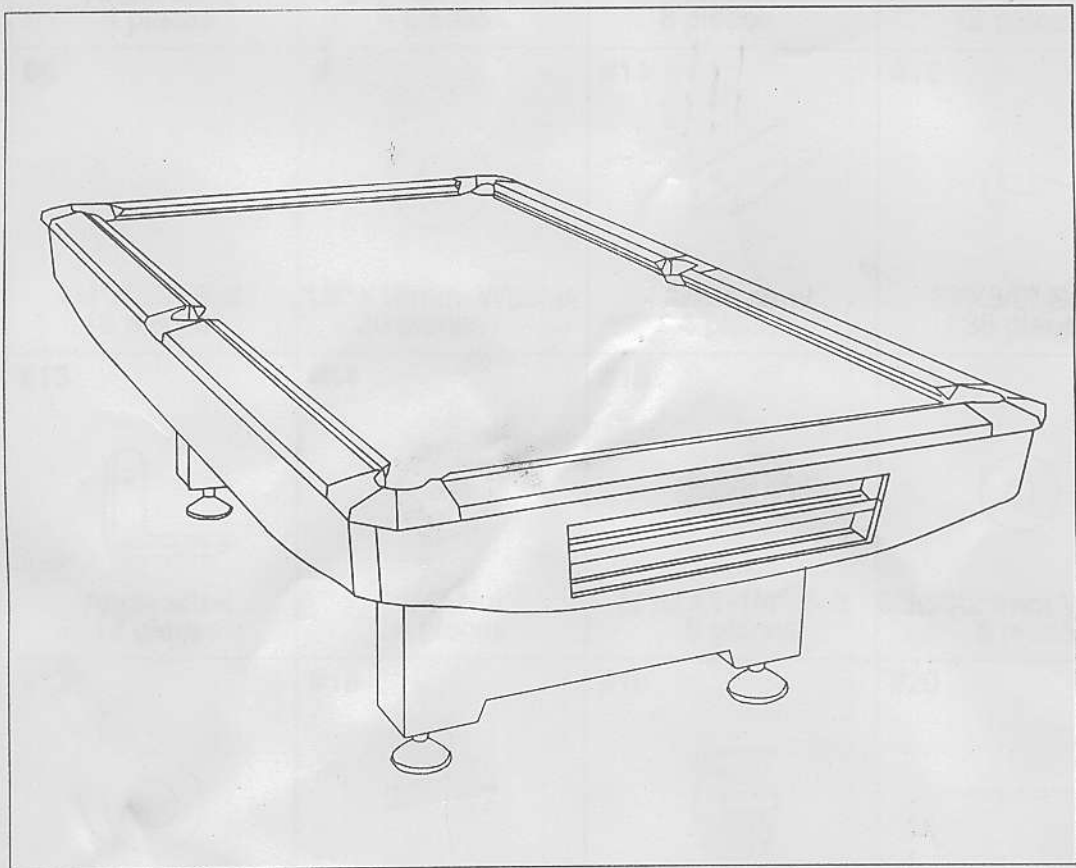

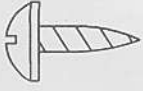









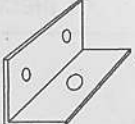

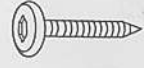

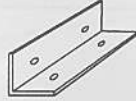

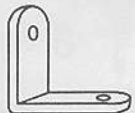

# BILLIARD TABLE

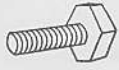

**ITEM NO. : 55006.091  
55006.090**

# Parts List

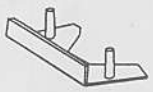
<p>#1</p>  <p>T4X1" Screw 16 pieces</p>	<p>#2</p>  <p>Leg lever 4 pieces</p>	<p>#3</p>  <p>1/2"X2" Bolt 8 pieces</p>	<p>#4</p>  <p>1/2"X28mm Washer 8 pieces</p>
<p>#5</p>  <p>Angle steel 4 pieces</p>	<p>#6</p>  <p>3/8"X3-1/4" Bolt 8 pieces</p>	<p>#7</p>  <p>16X31mm Nut 8 pieces</p>	<p>#8</p>  <p>12#X2-1/2" Screw 12 pieces</p>
<p>#9</p>  <p>1/4"X3/4" Bolt 16 pieces</p>	<p>#10</p>  <p>1/4"X16mm Washer 20 pieces</p>	<p>#11</p>  <p>Angle steel 4 pieces</p>	<p>#12</p>  <p>8#X5/8" Screw 36 pieces</p>
<p>#13</p>  <p>Angle steel 18 pieces</p>	<p>#14</p>  <p>1/4" Nut 4 pieces</p>	<p>#15</p>  <p>5/16"X1-1/4" Bolt 8 pieces</p>	<p>#16</p>  <p>5/16"X23mm Washer 8 pieces</p>
<p>#17</p>  <p>3/8"X38mm Washer 18 pieces</p>	<p>#18</p>  <p>3/8"X1-3/4" Bolt 18 pieces</p>	<p>#19</p>  <p>Basket 6 pieces</p>	<p>#20</p>  <p>Nail 30 pieces</p>
<p>#21</p>  <p>3/8"X2-1/4" Bolt 8 pieces</p>	<p>#22</p>  <p>3/8"X25mm Washer 24 pieces</p>	<p>#23</p>  <p>3/8" Nut 8 pieces</p>	<p>#24</p>  <p>Side Rail Corner 2 pieces</p>

# Parts List Cont'd

<p>#25</p>  <p>End rail corner 4 pieces</p>	<p>#26</p>  <p>F4X1-1/4" Screw 4 pieces</p>	<p>#27</p>  <p>1/4"X1-1/2" Screw 4 pieces</p>	<p>#28</p>  <p>Wrench 1 piece</p>
<p>#29</p>  <p>Allen 1 piece</p>	<p>A</p>  <p>Leg 2 pieces</p>	<p>B</p>  <p>Leg stretcher 1 piece</p>	<p>C</p>  <p>Main beam 2 pieces</p>
<p>D</p>  <p>End cross beam 2 pieces</p>	<p>E</p>  <p>Mid cross beam 2 pieces</p>	<p>F</p>  <p>End apron A 1 piece</p>	<p>G</p>  <p>End apron B 1 piece</p>
<p>H</p>  <p>Side apron 2 pieces</p>	<p>I</p>  <p>Side rail A 2 pieces</p>	<p>J</p>  <p>Side rail B 2 pieces</p>	<p>K</p>  <p>End rail 2 pieces</p>
<p>L</p>  <p>Slate 1 set</p>	<p>M</p>  <p>1 piece</p>		

### Step 1:

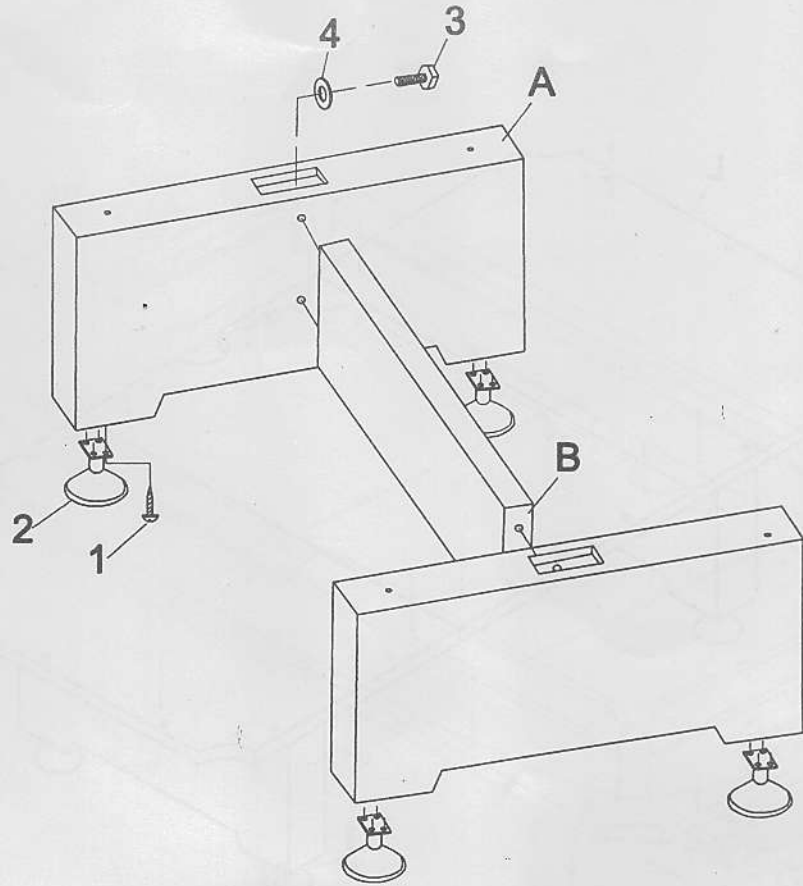

### Step 2:

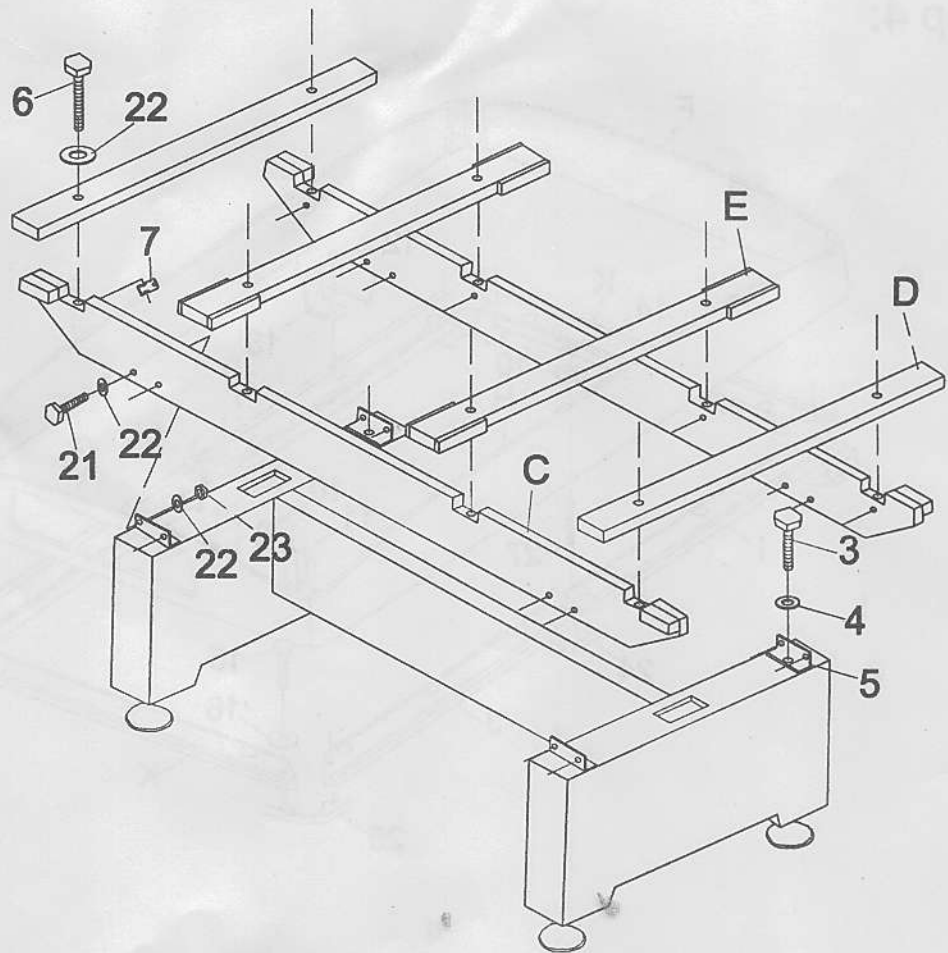

Step 3:

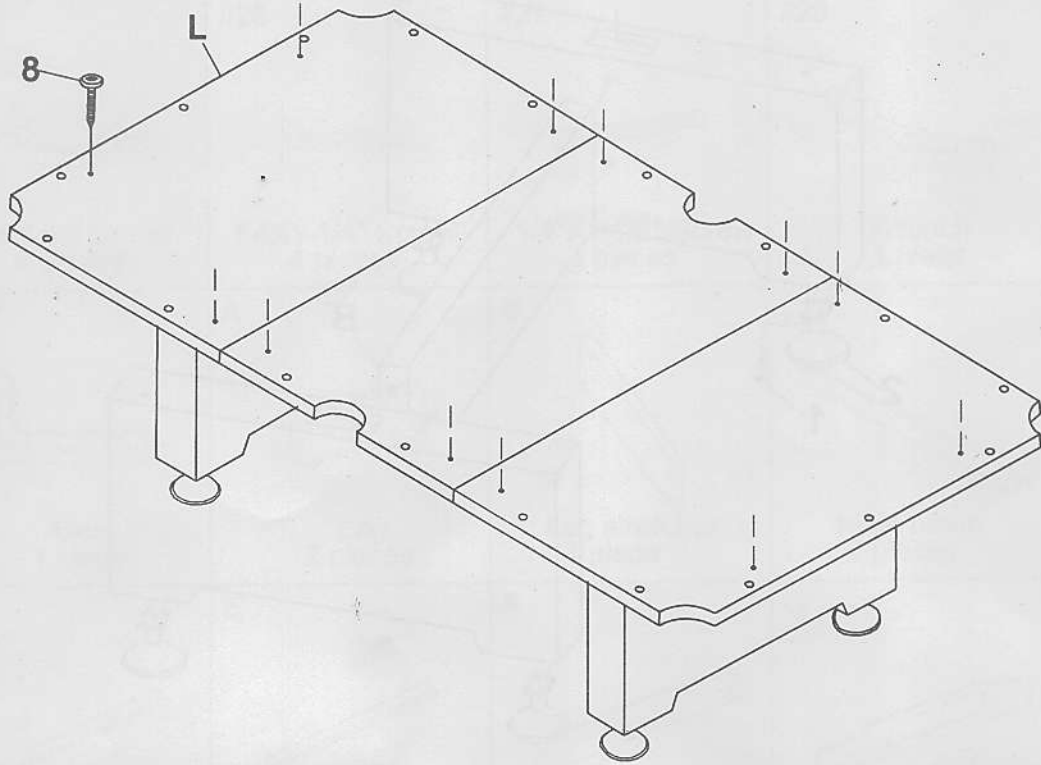

Step 4:

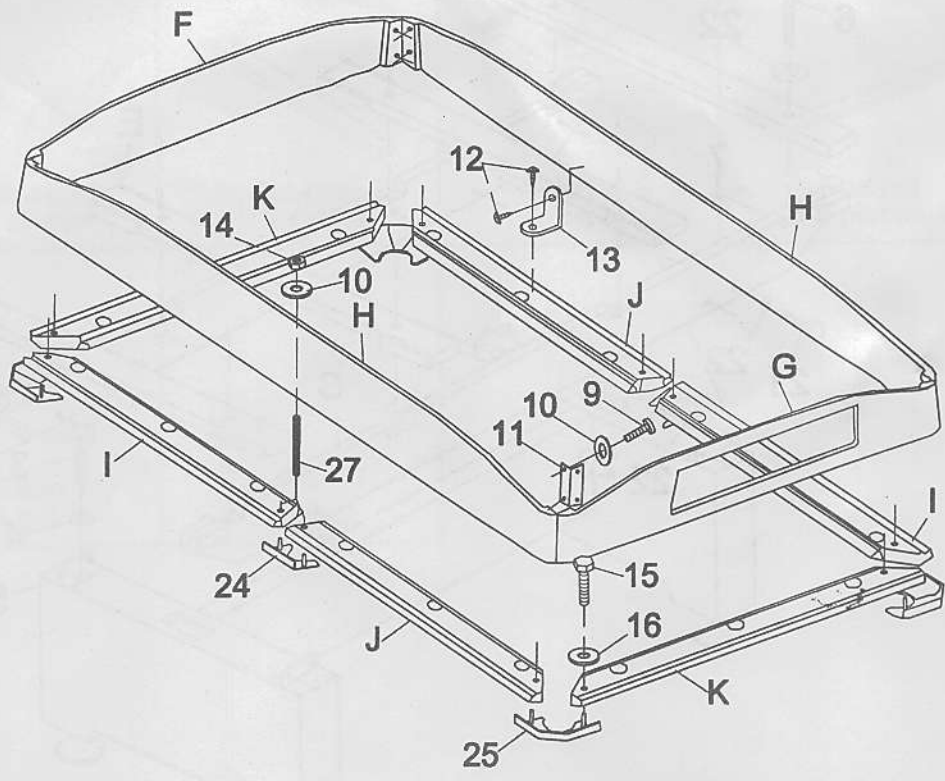

# Step 5:

